

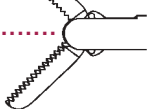
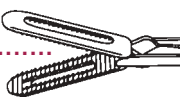

# ENDOSCOPIC INSTRUMENTS

All 32cm working length unless otherwise noted.

## Dissectors

GS 1000DN	General grasping forceps, dolphin nosed, 5mm..... standard handle, monopolar, insulated	
GS 1100*	Micro-dissecting forceps, fenestrated jaw, 5mm..... standard handle, monopolar, insulated	
GS 1300*	Maryland dissector, curved jaw, 10mm..... standard handle, monopolar, insulated	
GS 1305*	Maryland dissector, curved jaw, 5mm..... standard handle, monopolar, insulated	
GS 1310*	Thomas straight handle curved dissector, 5mm..... axial handle, insulated (shaft only)	
GS 1330	Acutely curved dissector 45 degree jaw, 10mm..... mixter clamp, standard handle	
GS 1340	Right angle dissector 90 degree jaw, 10mm..... standard handle	
GS 1365*	Right angle dissector 90 degree jaw, 5mm..... standard handle, monopolar, insulated	

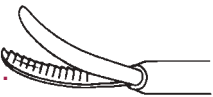
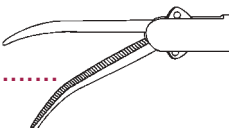
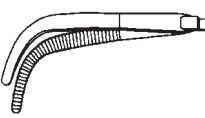
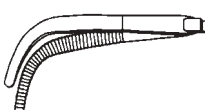
## Graspers

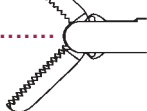
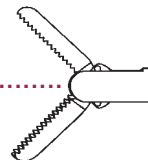
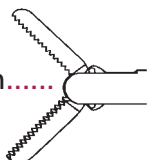
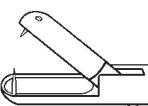
GS 1000*	General grasping forceps, 5mm..... standard handle, monopolar	
GS 1002*	Ratcheted grasping forceps, 5mm..... ratchet handle, insulated (shaft only)	
GS 1002-45	Ratcheted grasping forceps, 5mm, 45cm working length..... ratchet handle, insulated (shaft only)	
GS 1005*	Biopsy forceps with two teeth, 5mm..... spring handle	







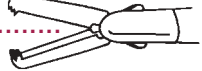

\* Offered as a rotatable 360° (shaft only).

**For product information and sales call Solos Endoscopy at 1-800-388-6445**

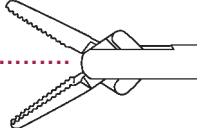
# ENDOSCOPIC INSTRUMENTS

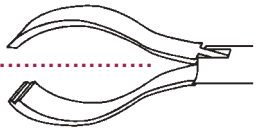
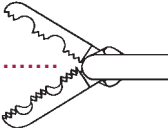
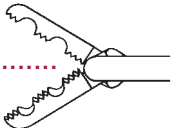
All 32cm working length unless otherwise noted.

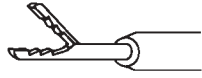
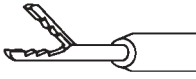
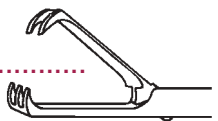
## Graspers (continued)







GS 1006*	Kocher grasping forceps, 5mm..... ratchet handle	
GS 1030*	Babcock grasper, 10mm..... ratchet handle	
GS 1031*	Dolphin nose grasper, 5mm, 2mm blunt tip..... standard handle, monopolar, insulated	
GS 1032*	Babcock grasper, 5mm..... ratchet handle	
GS 1033	Babcock grasper, 10mm..... standard handle	
GS 1098*	Tri grasper double grip jaw, 5mm..... ratchet handle	
GS 1099	Tri grasper double grip jaw, 10mm..... ratchet handle	
GS 1200	General purpose grasping/extracting forceps, 10mm..... standard handle	
GS 1400*	Toothed dissecting/grasping forceps, 5mm..... standard handle, monopolar, insulated	
GS 1402*	Toothed dissecting/grasping forceps, 5mm..... ratchet handle	
GS 1500	Heavy claw grasping forceps, 10mm..... 2x3 large toothed jaw, spring handle	
GS 1505*	General purpose heavy claw grasping forceps, 5mm..... spring handle, double action	

\* Offered as a rotatable 360° (shaft only).

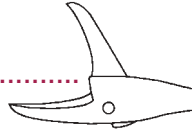
# ENDOSCOPIC INSTRUMENTS

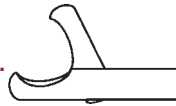
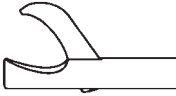
All 32cm working length unless otherwise noted.

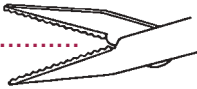
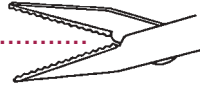
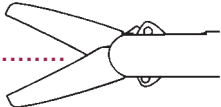
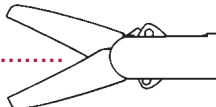
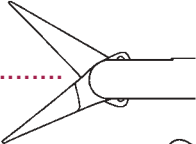
## Scissors

GS 2000*	Micro scissors, 3mm curved left blade, 5mm standard handle, monopolar, insulated	
GS 2005*	Micro scissors, 3mm straight blade, 5mm standard handle, monopolar, insulated	
GS 2100*	Hook suture scissors, 5mm standard handle	
GS 2150*	Hook scissors, 5mm standard handle, monopolar, insulated	
GS 2160	Semm heavy scissors, serrated jaw, 10mm standard handle, with LL rinsing channel	
GS 2200*	Straight scissors, serrated edge, 5mm standard handle	
GS 2205*	Straight scissors, serrated edge, 5mm standard handle, monopolar, insulated	
GS 2300*	Metzenbaum scissors, curved jaw, 5mm standard handle, monopolar, insulated	
GS 2310*	Metzenbaum scissors, delicate curved jaw, 5mm standard handle, monopolar, insulated	
GS 2400*	Metzenbaum scissors, straight jaw, 5mm standard handle, monopolar, insulated	
GS 2600	Mayo scissors, heavy design, curved jaw, 10mm standard handle, with LL rinsing channel	

\* Offered as a rotatable 360° (shaft only).

# ENDOSCOPIC INSTRUMENTS

All 32cm working length unless otherwise noted.

## Needle Holders

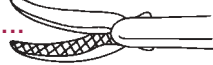
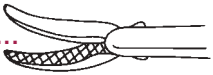
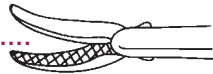
- |         |   |   |
|---------|---|---|
| GS 1035 | Reddick/Saye needle, holder curved left, 5mm.....<br>spring handle  |  |
| GS 1036 | Reddick/Saye needle, holder curved right, 5mm.....<br>spring handle |  |
| GS 1037 | Reddick/Saye needle, straight, 5mm.....<br>spring handle            |  |

## Fan Retractors

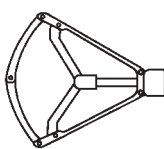
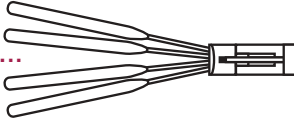
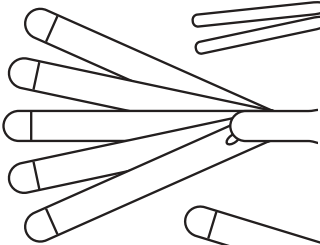
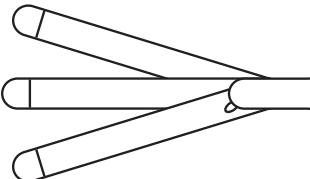
- |         |  |   |
|---------|--|---|
| GS 1160 | Wire type, 10mm, with set screw.....<br>opens to 6cm |    |
| GS 1166 | Wire type, 5mm, with set screw.....<br>opens to 3cm  |   |
| GS 1170 | Articulating, 10mm, 90 degrees.....                  |  |
| GS 1175 | Finger type, 10mm.....<br>with irrigation port       |   |
| GS 1180 | Finger type, 5mm.....<br>with irrigation port        |  |

## Cautery Instruments (Reusable)





- |         |  |   |
|---------|--|---|
| GS 5000 | Spatula suction coagulator, 5mm.....<br>spatula end, LL connection |  |
| GS 5005 | Spatula electrode, 5mm, spatula end, solid                         |   |

\* Offered as a rotatable 360° (shaft only).

# ENDOSCOPIC INSTRUMENTS

All 32cm working length unless otherwise noted.

## Cautery Instruments (Reusable) *(continued)*

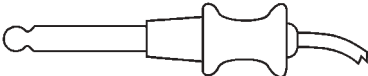
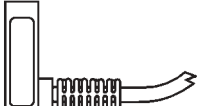
GS 5100	Blade suction coagulator, 5mm..... blade end, LL connection	
GS 5200	Hook suction coagulator, 5mm..... hook end, LL connection	
GS 5205	Hook electrode, 5mm, hook end, solid	
GS 5230	Blunt tip suction coagulator, 5mm..... blunt end, LL connection	
GS 5235	Blunt electrode, 5mm, blunt end, solid	
GS 5240	Needle tip suction coagulator, 5mm..... needle tip, LL connection	
GS 5250	Right angle hook suction coagulator, 5mm..... right angle hook end, LL connection	
GS 5255	Right angle electrode, 5mm, right angle hook end, solid	
GS 6000	Monopolar connecting cord, reusable.....	
GS 6005	Disposable monopolar connecting cord, 10 per box	

## Verres Insufflation Needle (Reusable)

GS 5600	120mm working length	
GS 5602	100mm working length	
GS 5603	150mm working length	

## ENDOSCOPIC INSTRUMENTS

All 32cm working length unless otherwise noted.

### Clip Applying Forceps

---

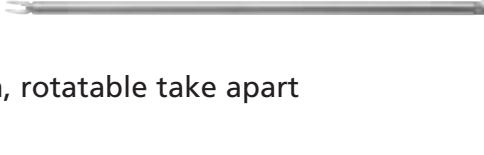
- |           |   |  |
|-----------|---|--|
| GS 7000   | Medium clip size, 10mm.....                                     |  |
| GS 7005s  | Ethicon, small clip size, 10mm, rotatable take apart            |  |
| GS 7005m  | Ethicon, medium clip size, 10mm, rotatable take apart           |  |
| GS 7005ml | Ethicon, medium-large clip size, 10mm, rotatable take apart     |  |
| GS 7006   | Insert only, Ethicon small clip size                            |  |
| GS 7007   | Insert only, Ethicon medium clip size                           |  |
| GS 7008   | Insert only, Ethicon medium-large clip size                     |  |
| GS 7010s  | Pilling-Weck, small clip size, 10mm, rotatable take apart       |  |
| GS 7010m  | Pilling-Weck, medium clip size, 10mm, rotatable take apart      |  |
| GS 7010ml | Pilling-Weck medium-large clip size, 10mm, rotatable take apart |  |
| GS 7011   | Insert only, Pilling-Weck small clip size                       |  |
| GS 7012   | Insert only, Pilling-Weck medium clip size                      |  |
| GS 7013   | Insert only, Pilling-Weck medium-large clip size                |  |

### Other Instruments

---

- |         |                                      |
|---------|--------------------------------------|
| GS 1115 | S-Shaped retractor, 1/2" width large |
| GS 1116 | S-Shaped retractor, 3/8" width small |
| GS 4125 | Knot pusher, 5mm.....                |

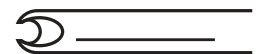

# ENDOSCOPIC INSTRUMENTS

All 32cm working length unless otherwise noted.

## Other Instruments *(continued)*

---

GS 5650 Puncture needle, 5mm.....  
with LL connection

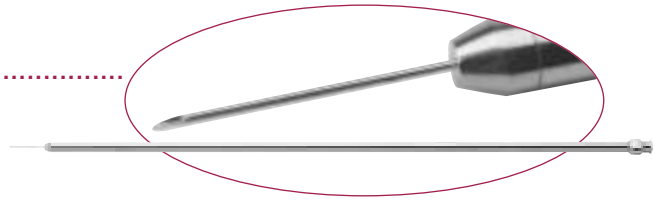

GS 5651 Puncture needle, 5mm  
45cm working length, with LL connection

GS 7100 Cholangiogram clamp, 5mm, ratchet handle.....

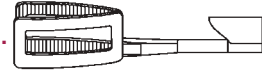

GS 4400 O'Toole-Poole suction/irrigation tube, 5mm  
with double trumpet control valve to facilitate irrigation and suction



GS 4870 LIA tubing set (GS 9700), 5 per box

\* Offered as a rotatable 360° (shaft only).

# LAPAROSCOPIC INSTRUMENTS

All 32cm working length unless otherwise noted.

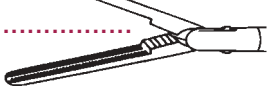
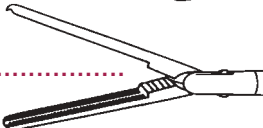
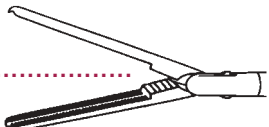
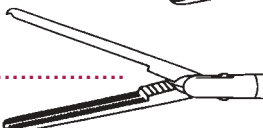
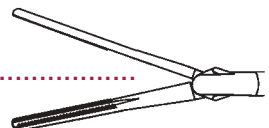
## General Surgery Instruments

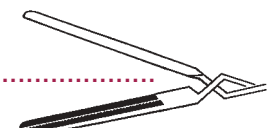
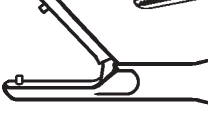
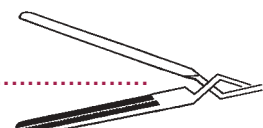
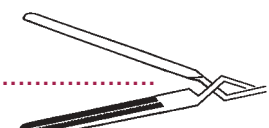
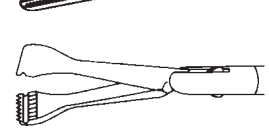
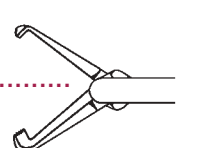
GI 1050	Glassman-type clamp, 20mm jaw, 5mm standard handle	
GI 1055	Glassman-type clamp, 40mm jaw, 5mm standard handle	
GI 1065*	Glassman-type clamp, 40mm jaw, 5mm ratchet handle	
GI 1070	Glassman-type clamp, 60mm jaw, 5mm ratchet handle (replaced the GI 1068)	
GI 1075	Debaquey-type tissue forceps, 20mm jaw, 5mm standard handle	
GI 1085**	Endoscopic bowel bulldog clamp, 40mm jaw, 5mm	
GI 1086**	Endoscopic bowel bulldog clamp, 60mm jaw, 5mm	
GI 1088	Vascular and bowel bulldog clamp applier, 10mm, compression handle	
GI 1090**	Endoscopic vascular bulldog clamp, 10mm jaw, 5mm	
GI 1095**	Endoscopic vascular bulldog clamp, 20mm jaw, 5mm	
GI 1190	Endoscopic Allis clamp, 5mm ratchet handle	
GI 1191*	Allis clamp, atraumatic, 5mm ratchet handle	

\* Offered as a rotatable 360° (shaft only).

\*\* Attachment clips used with GI 1088, clamp applier.



# LAPAROSCOPIC INSTRUMENTS

All 32cm working length unless otherwise noted.

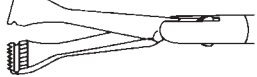
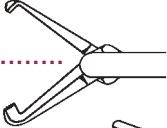
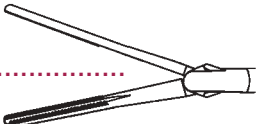

## General Surgery Instruments *(continued)*

---

- |         |  |   |
|---------|--|---|
| GI 1195 | Endoscopic Allis clamp, 10mm.....<br>ratchet handle                                      |  |
| GI 1196 | Allis clamp, atraumatic, 10mm.....<br>ratchet handle                                     |  |
| GI 1275 | Debaquey-type tissue forceps, 3mm wide jaw.....<br>standard handle, monopolar, insulated |  |

## Lymphadenectomy Instruments

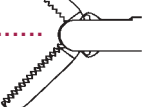
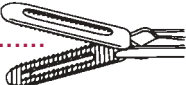
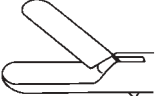
---

- |          |   |   |
|----------|---|---|
| GU 1004  | Grasping forceps, 5mm, 27cm working length.....<br>ratchet handle, insulated (shaft only)   |    |
| GU 1110  | Needle nose forceps, 5mm, 27cm working length.....<br>standard handle, monopolar, insulated |   |
| GU 1540  | Spoon forceps, 10mm.....<br>spring handle   |  |
| GU 2210* | Serrated straight scissors, 5mm, 27cm working length.....<br>standard handle                |  |

## Gynecology Instruments

---

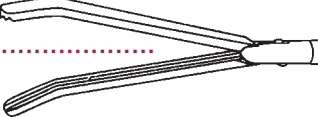
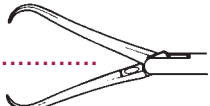
- |         |  |   |
|---------|--|---|
| GY 6100 | Bipolar connector cord, 12 feet.....<br>(Valley Lab & Conmed/Birtcher) |  |
| GY 7500 | Heany clamp, 10mm, curved long jaw.....<br>ratchet handle              |   |
| GY 7550 | Endoscopic tenaculum clamp, straight jaw, 10mm.....<br>ratchet handle  |  |

\* Offered as a rotatable 360° (shaft only).

# LAPAROSCOPIC INSTRUMENTS

All 32cm working length unless otherwise noted.

## Thorascopy Instruments

---

GS 1600 Pennington style lung clamp.....  
10mm, ratchet handle

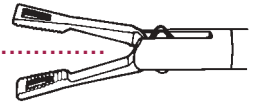

GS 1605\* Pennington style lung clamp.....  
5mm, ratchet handle

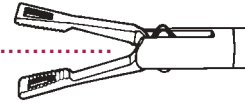

GS 1620 Bronchus clamp, straight jaw.....  
10mm, ratchet handle



GS 1650 Vascular occlusion clamp.....  
10mm, ratchet handle

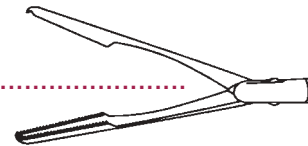

\* Offered as a rotatable 360° (shaft only).

## Instrument Accessories

---

GS 0900 Flush port cap, 5 per package

GS 0910 Screw for 10mm fan retractor, 5 per package

GS 0920 Tip protector for 10mm instruments

GS 0930 Tip protector for 5mm instruments

GS 4311 Replacement seal for 5mm cholangiogram clamp